

---

# ATLANTA

## STRETCH

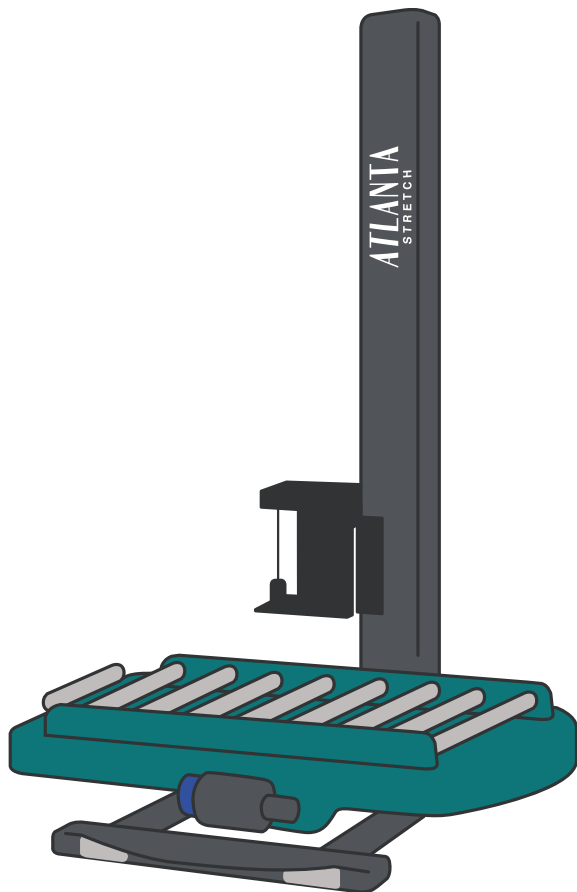

*MYTHO A*

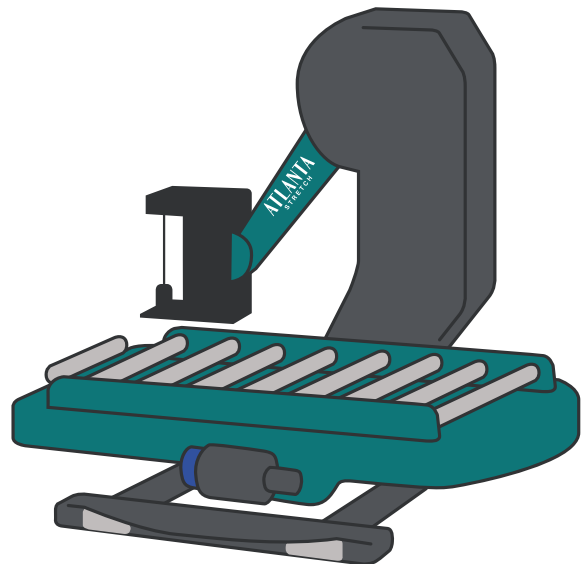

*MYTHO A ARM*

AUTOMATIC WRAPPING MACHINE  
EASY INSTALLATION

**Turntable for wrapping pallets  
with stretch film**

## MYTHO A MAST

Input: 380 Volt  
3 PHASE+N+T

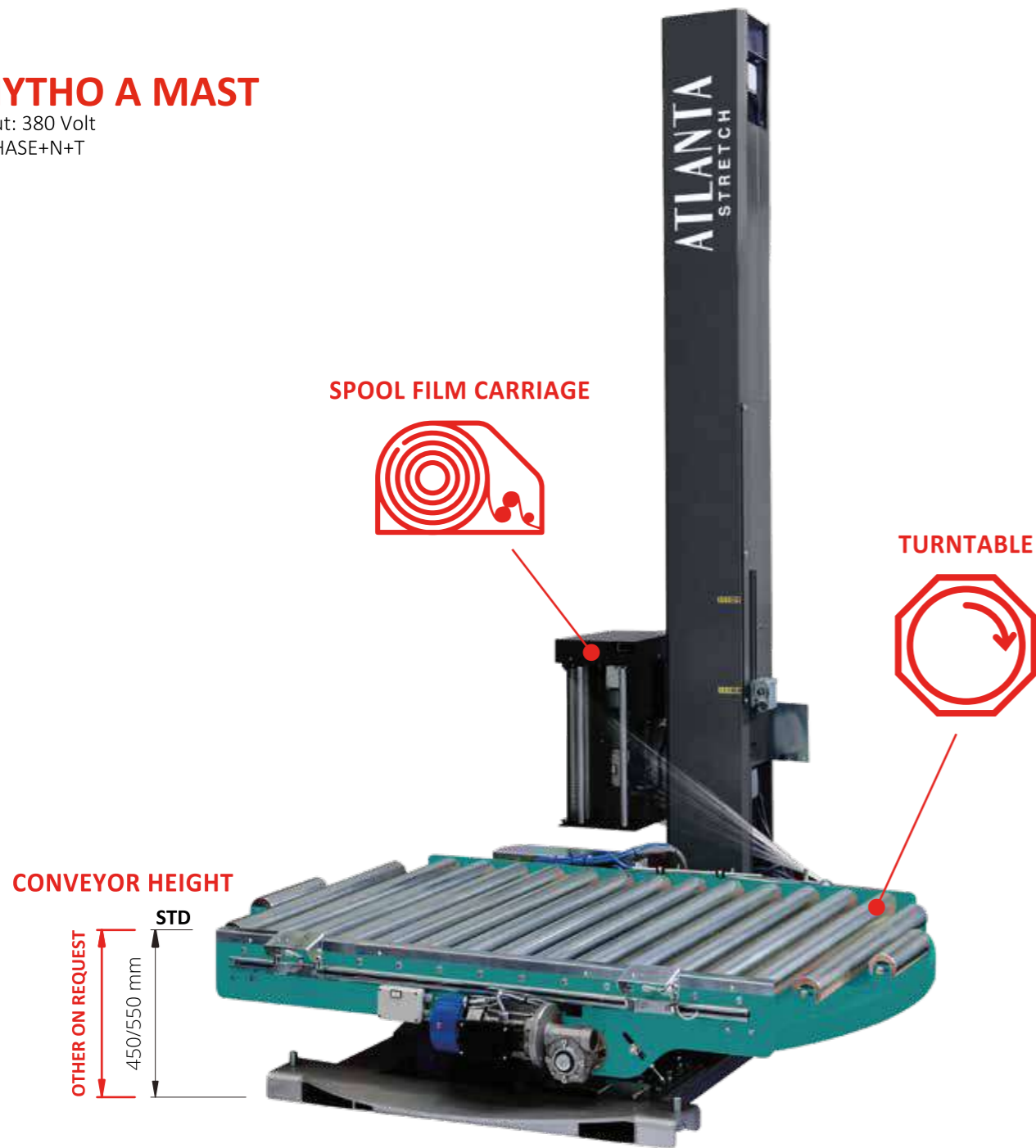

## MYTHO A ARM

Input: 380 Volt  
3 PHASE+N+T

### SPOOL FILM CARRIAGE

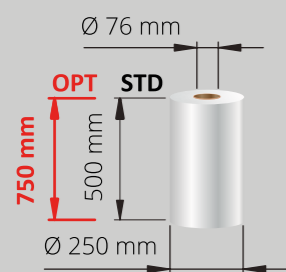
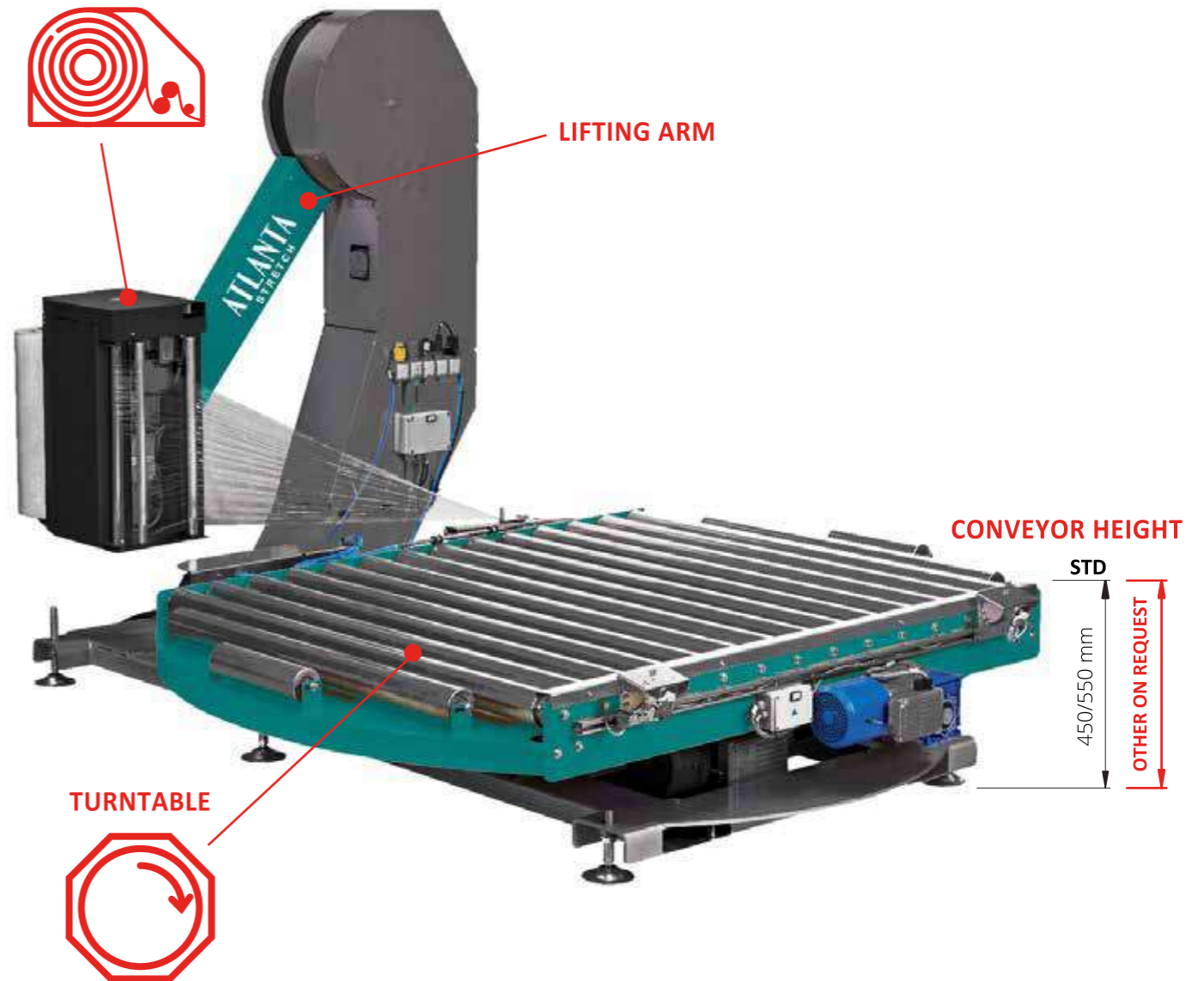

### PALLET DIMENSIONS

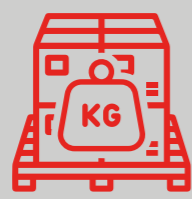

Up to 3500 Kg

**Mytho Mast**  
H = 2200 STD  
H = 2500 OPT  
H = 2700 OPT  
H = 3200 OPT  
H = 3500 OPT  
H = 3900 OPT

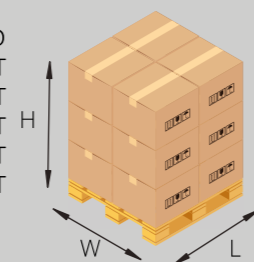

**WxL mm**  
800x1200 mm  
1000x1200 mm  
1200x1200 mm  
**OTHER ON REQUEST**

### APPLICATIONS





## SELLING POINTS & MAIN OPTIONALS



### WELDING UNIT

- IT** Saldatore dotato di 2 piastre riscaldate in teflon. La temperatura è regolabile elettronicamente e controllata da un termo regolatore
- EN** Welding unit with 2 teflonate hot plates. The temperature is electronically adjustable and controlled by termoregulator.
- FR** Unité de soudage avec 2 plaques chauffantes en téflonate. La température est réglable électroniquement et contrôlée par termorégulateur.
- DE** Schweißgerät mit 2 Teflonat-Heizplatten. Die Temperatur ist elektronisch einstellbar und wird durch einen Temperaturregler gesteuert.
- ES** Unidad de soldadura con 2 placas calientes de teflonato. La temperatura es regulable electrónicamente y controlada por termorregulador.



### CONTRAST PLATE

- IT** Ciò garantisce una saldatura perfetta anche con pallet di forma irregolare.
- EN** This guarantees perfect welding even with irregularly shaped pallets.
- FR** Cela garantit une soudure parfaite même avec des palettes de forme irrégulière.
- DE** Dies garantiert perfektes Schweißen auch bei unregelmäßig geformten Paletten.
- ES** Esto garantiza una soldadura perfecta incluso con palets de forma irregular.

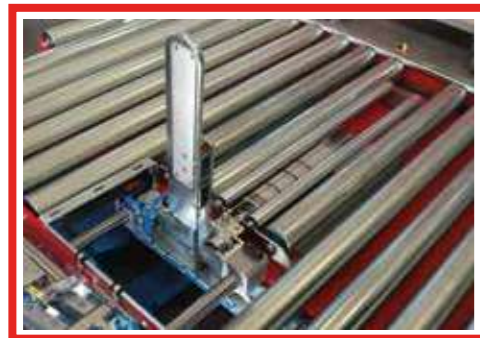

### SELF ADJUSTING WELDING UNIT

- IT** Sistema saldatura del film estensibile autoregolante per qualsiasi dimensione del pallet.
- EN** Film weld unit self adjusting for any size of pallet.
- FR** Système de soudure du film étirable à réglage automatique pour toutes dimensions de la palette.
- DE** Selbsteinstellendes Folienende Verschweißsystem passt sich auf sämtliche Palettengrößen automatisch an.
- ES** Sistema soldadura del film extensible autorregulable para cualquier dimensión de palet.



### CORNER BOARDS APPLICATOR

- IT** Metti angolare automatico. Automatic corner boards device to automatically place cardboard
- EN** Protectors to the load corners.
- FR** Dépose cornière automatique.
- DE** Automatische Kantenschutz-Applikator.
- ES** Colocador de cantonerasautomático.



## SELLING POINTS & MAIN OPTIONALS

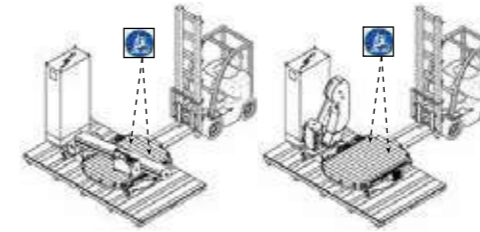

### SMALL FOOTPRINT

- IT** Minimo ingombro, trasporto facile, costi di gestione ridotti.
- EN** Small footprint, easy transport, reduced operating costs.
- FR** Faible encombrement, transport facile, coûts d'exploitation réduits.
- DE** Geringer Platzbedarf, einfachen Transport, Senkung der Betriebskosten.
- ES** Ocupa poco espacio, fácil transporte, reducción de los costos de operación.

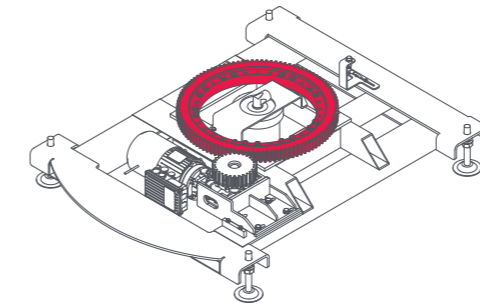

### EASY MAINTENANCE, DURABLE TRANSMISSION

- IT** Ralla rotazione tavola a dentatura esterna affidabile e duratura.
- EN** Heavy duty bearing support with external pinion drive, reliable and durable.
- FR** Couronne de rotation de la table à engrenage externe, fiable et durable.
- DE** Wartungszugänglicher Antrieb und Drehtellerlagerung, zuverlässig und langlebig.
- ES** Rotación mediante una corona dentada externa, fiable y duradero.

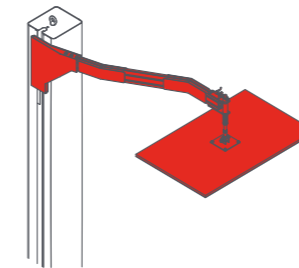

### TOP PLATE UNIT

- IT** Pressore tenuta pallet. Sistema a colonna consigliato per altezza superiore a 2500 mm.
- EN** Top plate unit. Recommended for unstable or tall loads over 2500 mm.
- FR** Plateau stabilisateur de charge. Système à colonne conseillé pour hauteur supérieur à 2500 mm.
- DE** Palettenniederhalter. Traditionelle Mast für Wickelhöhe über 2500 mm.
- ES** Presor toma palet. Sistema de columna aconsejado para altura superior a 2500 mm.

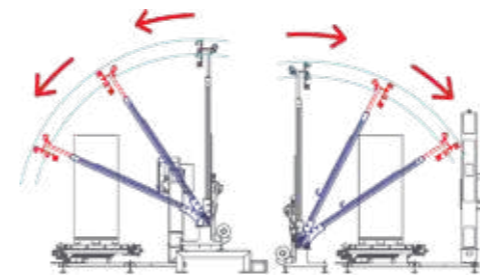

### TOP COVER SYSTEM

- IT** Protezione anti acqua e anti polvere.
- EN** Waterproof and dustproof pallet protection.
- FR** Protection de palette étanche et anti-poussière.
- DE** Wasser- und staubdichter Palettenschutz.
- ES** Protección de palés a prueba de agua y polvo.

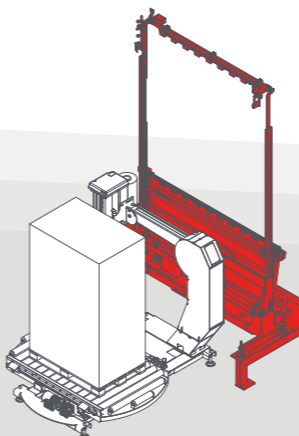

### TOP COVER SYSTEM BACK THE LIFTING ARM

- IT** Possibilità di posizionare il top cover dietro il braccio meccanico per consentire il carico e scarico su tre lati.
- EN** Possibility to place it also back side of the lifting arm to allow the charge and discharge from three sides.
- FR** Possibilité de le placer également à l'arrière du bras de levage pour permettre la charge et la décharge sur trois côtés.
- DE** Möglichkeit, es auch hinter dem Hebearm zu platzieren, um das Laden und Entladen auf drei Seiten zu ermöglichen.
- ES** Posibilidad de colocarlo también detrás del brazo de elevación para permitir la carga y descarga en tres lados.





## SELLING POINTS & MAIN OPTIONALS

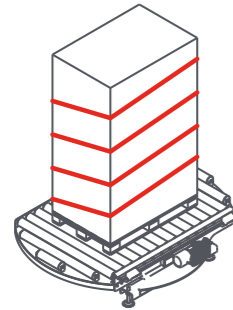

### ROPING SYSTEM

- IT** Sistema a corda: Permette di ridurre l'altezza del film formando un cordone che assicura una più efficiente stabilizzazione del carico.
- EN** Roping System: Reducing the film width to form a rope to ensure more effective load stabilisation.
- FR** Systeme permettant de réduire la laize du film en formant un cordon qui assure une meilleure stabilisation de la charge.
- DE** Schnurrvorrichtung: Reduzierung der Folienbreite zur Schnur um eine bessere Stabilisierung der Ladung zu gewährleisten.
- ES** Sistema de Cordón. Permite reducir la altura del film formando un cordon que asegura con mas eficacia la estabilidad de la carga.

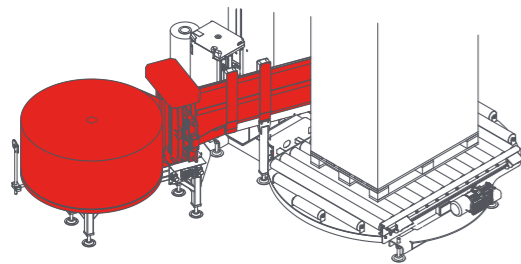

### AUTOMATIC CARTON SHEET APPLICATOR

- IT** Ulteriore protezione totale o parziale del prodotto.
- EN** Total or partial extra protection for the product.
- FR** Protection supplémentaire totale ou partielle du produit.
- DE** Vollständiger oder teilweiser zusätzlicher Schutz für das Produkt.
- ES** Protección extra total o parcial del producto.

## MYTHO A DOUBLE

Input: 380 Volt  
3 PHASE 50/60 Hz+N+T



### DOUBLE CARRIAGE TO ENABLE 25% EXTRA OUTPUT

#### MYTHO A DOUBLE

- IT** 25% di produttività in più in una piccola area di lavoro
- EN** 25% Extra output in a small working area
- FR** 25% de rendement supplémentaire dans une petite zone de travail
- DE** 25% Mehrleistung auf kleinem Arbeitsbereich
- ES** 25% de rendimiento adicional en un área de trabajo pequeña



## SPOOL FILM CARRIAGE



### EASY FILM CHANGE

- IT** Sistema di prestiroelettronico con inserimento rapido del film estensibile.
- EN** Electronically controlled pre-stretch carriage with rapid film loading system.
- FR** Pré-étiragemotoriséet asservià chargementrapidedu film étirable.
- DE** ElektronischgesteuerteVordehnungmitFolienschnellwechselsystem).
- ES** Sistema de pre-estiroelectrónicocon inserciónrápidadel film extensible.

### FE

- IT** Frizione elettromagnetica regolabile da pannello comandi.
- EN** Electromagnetic friction adjustable from control panel.
- FR** Frein électromagnétique réglable depuis le panneau de commande.
- DE** Elektromagnetische Bremse auf Umlenkwalze vom Bedienpult instellbar.
- ES** Fricción electromagética regulable desde el panel de comandos.

### PRS POWER ROLLER STRETCH

- IT** Sistema di prestiro motorizzato a 3rulli comandato elettronicamente con rapporti intercambiabili: 150- 200- 250%.
- EN** Motorized pre-stretch system with 3 driven rollers electronically controlled with interchangeable ratios: 150- 200- 250%.
- FR** Système de pré-étirage motorisé et asservi à 3 rouleaux, rapports interchangeables: 150- 200- 250%.
- DE** Angetriebener Vordehnssystem mit 3 Vordehnrollen, elektronisch gesteuert mit leicht wechselbarer Zahnradsätzen: 150- 200- 250%.
- ES** Sistema de prestiro motorizado con 3 rodillos, comandado electrónicamente con desarrollos intercambiables: 150- 200- 250%.

### PS POWER STRETCH

- IT** Sistema di motorizzato a 3 rulli con 2 motori e variazione da 120 a 350% regolabile da quadro comandi.
- EN** Motorized pre-stretch system with 3 driven rollers and 2 motors adjustable between 120 to 350% from control panel.
- FR** Système de pré-étirage motorisé et asservi à 3 rouleaux et 2 moteurs, rapport ajustable de 120 à 350% depuis le panneau de commande.
- DE** Angetriebener Vordehnssystem mit 3 Vordehnrollen und 2 Motoren, stufenlos regelbare Werte zwischen 120 und 350% von Bedienpult.
- ES** Sistema de prestiro motorizado con 3 rodillos y 2 motores, regulable da 120 a 350% desde el panel de comandos.

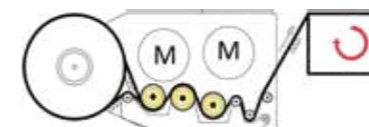
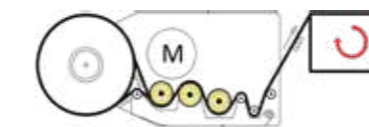

## WRAPPING PROGRAMS

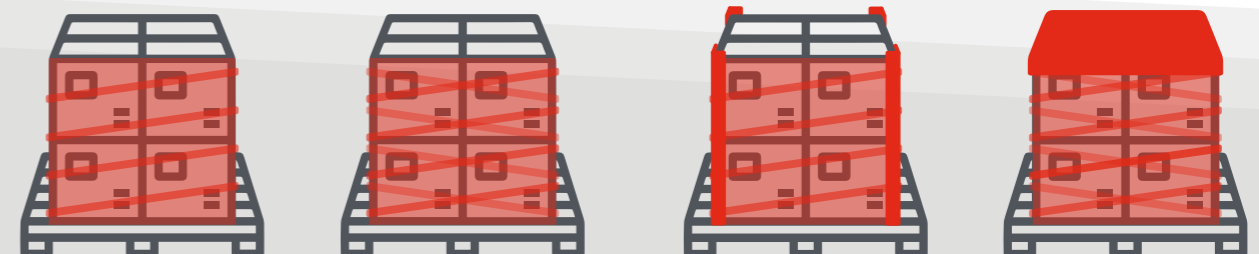

# AUTOMATIC RANGE

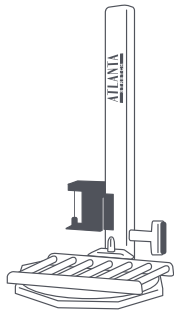

MYTHO STATION

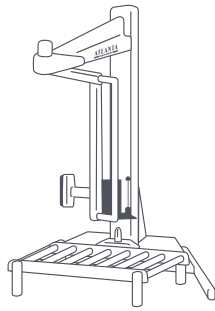

LYBRA STATION

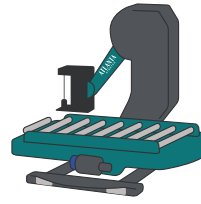

MYTHO A ARM

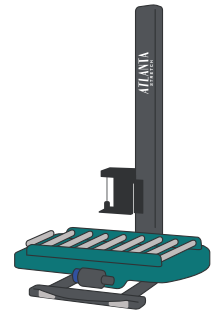

MYTHO A MAST

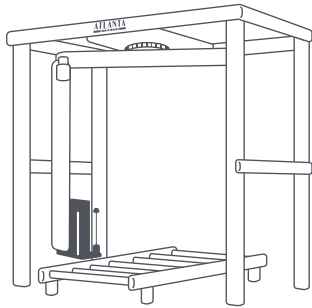

REVOLUTION LS

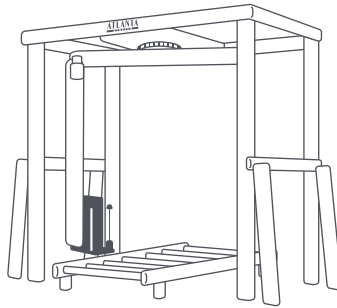

REVOLUTION HS

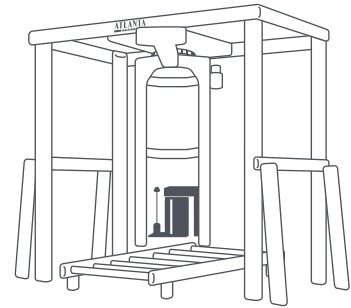

REVOLUTION HD

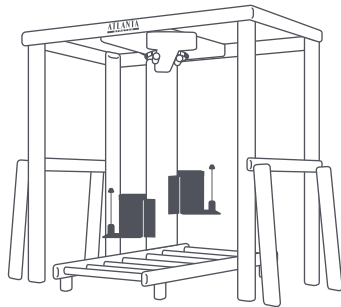

REVOLUTION DOUBLE

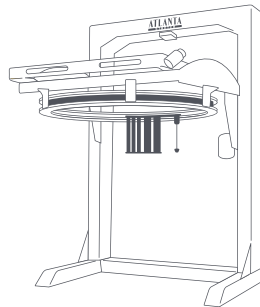

OMEGA

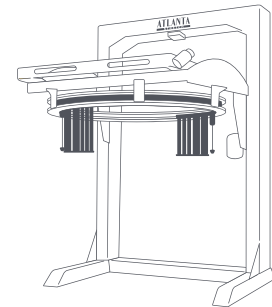

OMEGA DOUBLE

Atlanta Stretch Authorized dealer

**ATLANTA**  
**STRETCH**  
turning business around

Headquarter: Atlanta Stretch Italy Spa

Subsidiaries: Atlanta Stretch Australia - Atlanta Stretch China - Atlanta Stretch Deutschland - Atlanta Stretch France - Atlanta Stretch Iberica - Atlanta Stretch India - Atlanta Stretch Mexico - Atlanta Stretch Russia - Atlanta Stretch SEA - Atlanta Stretch Sweden - Atlanta Stretch Turkey - Atlanta Stretch UK



View all optional tools here

[www.atlantastretch.com](http://www.atlantastretch.com)

Find all our dealers

