



COMARME

GEM 52



LATEST GENERATION

GEM 52

[It]
DESCRIZIONE

Nastratrice per scatole a formato fisso.

La serie Gem segue una filosofia costruttiva modulare, consentendo uniformità e versatilità dei pezzi di ricambio.

[En]
DESCRIPTION

Uniform case sealer.

The GEM series is based on a modular construction concept for uniformity and adaptability of spare parts.

[Fr]
DESCRIPTION

Machine a fermer les caisses americaines monoformat.

La série Gem adopte une conception modulaire qui permet d'utiliser les pièces standard.

[De]
BESCHREIBUNG

Kartonschachtel-verschliessmaschine für gleichbleibende formate.

Die Serie GEM folgt einer Modularbauweise und ermöglicht damit Gleichförmigkeit und Vielseitigkeit bei den Ersatzteilen.

[Es]
DESCRIPCIÓN

Precintadora para cajas de formato fijo.

La serie Gem sigue un diseño modular, lo que permite la consistencia y versatilidad.

DATI TECNICI:

TECHNICAL DATA:

DONNÉES TECHNIQUES:

TECHNISCHE DATEN:

FICHA TÉCNICA:

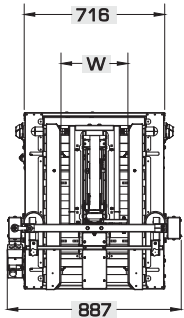

measure/measures/mesures/maßnahmen/medidas: mm

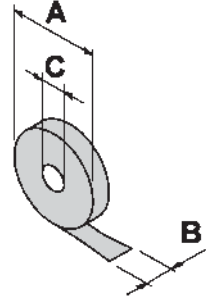
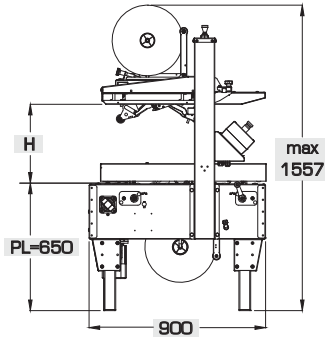

A	MAX 360 mm (14")
B	25÷75 mm (1"÷3")
C	76 mm (3")

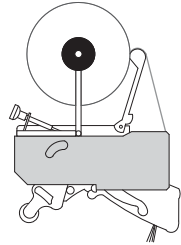

- Teste Nastranti:
- Taping Heads:
- Têtes de pose:
- Klebeköpfe:
- Cabezal de precinto:

T21-T21,5-T22-T23
T32-T33
TH22-TH23

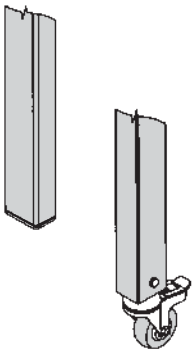

- Gambe con piedino fisso
- Legs with fixed foot
- Pieds à base fixe
- Standbeine mit fixem Fuß
- Patas con pie fijo

OPTIONAL:

- Gambe con ruote
- Legs with wheels
- Pieds à roulettes
- Standbeine mit Rädern
- Patas con ruedas

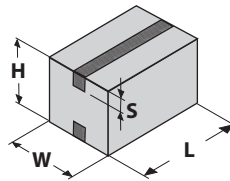

	MIN	MAX
L	150 mm	∞
W	100 mm	500 mm
H	100 mm	500 mm
S	25 mm	75 mm

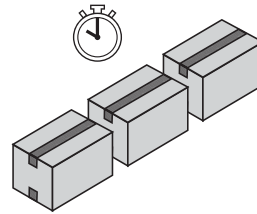

- Produzione media:
- Average production:
- Production moyenne:
- Durchschnittliche Produktion:
- Producción promedio:

800 $\frac{u}{h}$

- Velocità di trasferimento scatola:
- Box transfer speed:
- Vitesse de transfert de la boîte:
- Transportgeschwindigkeit der Kartons:
- Velocidad de desplazamiento caja:

~22 $\frac{mt}{min}$



- Alimentazione:
- Power supply:
- Alimentation:
- Speisung:
- Alimentación:

3 / \pm

- Potenza installata:
- Installed power:
- Puissance installée:
- Eingerichtete Leistung:
- Potencia instalada:

0,25 kW

- Protezione elettrica:
- Electrical protection:
- Protection électrique:
- Stromschutz:
- Protección eléctrica:

IP54



- Temperatura di utilizzo:
- Temperature of use:
- Température d'utilisation:
- Betriebstemperatur:
- Temperatura de uso:

	MIN	MAX
°C	+5	+35
°F	+41	+95



- Peso:
- Weight:
- Poids:
- Gewicht:
- Peso:

112 Kg

Distributed by

COMARME

COMARME S.r.l. a socio unico

sede operativa (factory)
Quartiere Mirabella snc, 20081 Abbiategrasso (MI) - ITALY
Tel. +39 02 9422002 - Fax +39 02 9422096

e-mail: info@comarmesrl.com - website: www.comarmesrl.com